

WINDOWS

SOLEAL NEXT 75

THE UNIVERSAL WINDOW

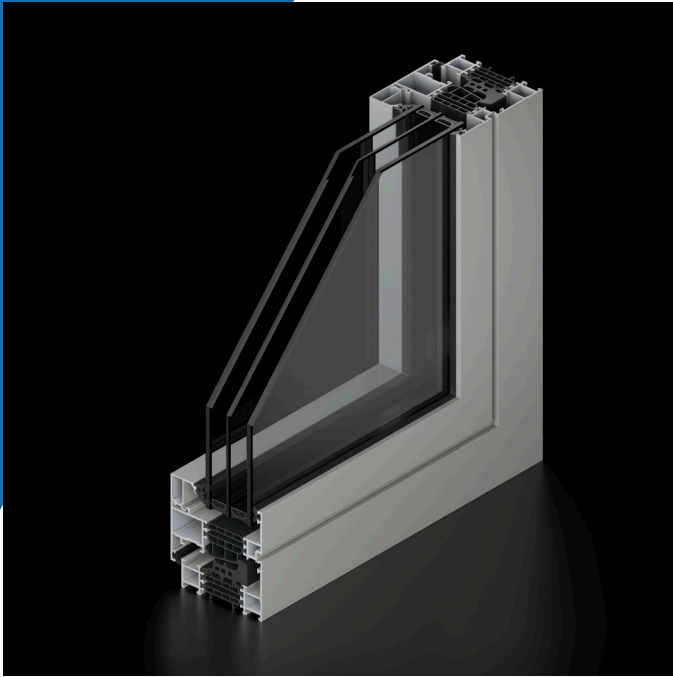

SOLEAL Next casement is available in Visible and Minimal design, open-in and open-out to adapt to all types of architectures. There are multiple applications, shapes and colours.

High performance levels for weather tightness, thermal, acoustic and sustainability comply with most international standards

Multiple choice of design and aesthetics

- Minimal open-in, Visible open-in and open-out
- Concealed hardware
- Concealed handle and drainage
- EXCLUSIVE® handle collection
- EXCLUSIVE® colour range

Large dimensions

- Height: up to 3 meters
- Glazing thickness: up to 69 mm
- Infill weight: up to 160 kg

Numerous applications

- Open-in, open-out
- Façade and other ranges integration
- Composite assemblies
- Horizontal and vertical pivot
- Residential door
- Juliet balcony
- Motorisation available for tilt
- Magnetic window contact
- Wireless window contact

Safety and accessibility

- Burglary resistance RC2, RC3 and PAS24
- Security glazing beads for glass panel installation from the outside, including open-out
- Antibacterial coating on handles (on demand)
- Reduced threshold for disabled: 15-20 mm

Sustainability

- SOLEAL Next is made in Hydro CIRCAL®, aluminium made with a minimum of 75% recycled end-of-life aluminium.
- PVC-free components
- Cradle to Cradle®: under certification
- Dynamic EPD available on TechDesign
- 75% recycled and 95% recyclable



Thermal performance: U_w up to 0.79 W/m²K,
window Minimal Open-In, 1 vent, (WxH) 1230x1480 mm

Air permeability: Class 4

Water tightness:

- up to 1500 Pa for open-in
- up to 1800 Pa for open-out

Wind pressure resistance: Class 5

Acoustic performance: R_w up to 48 dB



By  Hydro

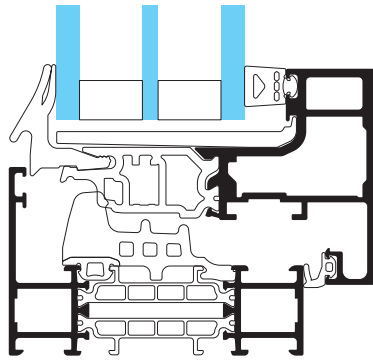

SOLEAL NEXT 75 Minimal Open-In

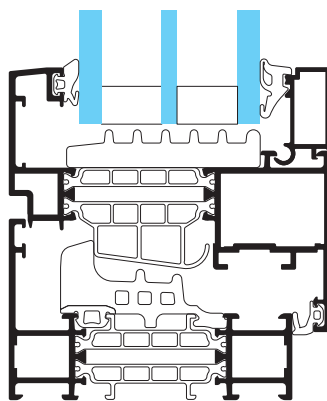

SOLEAL NEXT 75 Visible Open-In

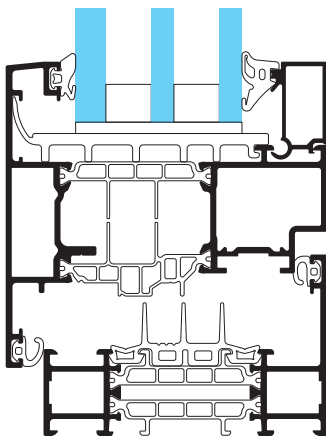

SOLEAL NEXT 75 Visible Open-Out

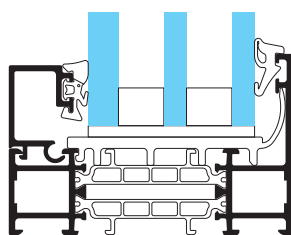

SOLEAL NEXT 75 fixed frame

Open-in



Fixed frame



Bottom-hung

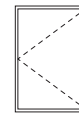

Side hung
1 vent

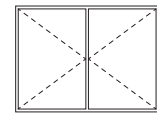

Side hung
2 vents

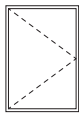

Fireman
access



Turn/tilt or
tilt/turn
1 vent

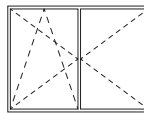

Turn/tilt or
tilt/turn
2 vents

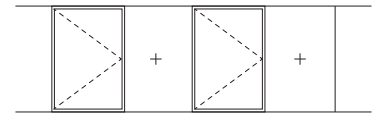

Ribbon window

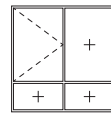

Fixed composite
open-in window

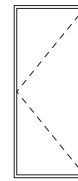

Residential door
with threshold
1 vent

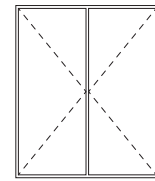

Residential door
with threshold
2 vents

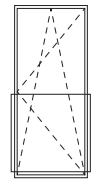

Juliet balcony

Open-Out

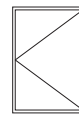

Side hung
1 vent

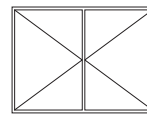

Side hung
2 vents

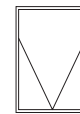

Top-hung

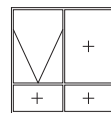

Fixed composite
top-hung

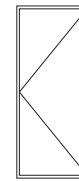

Residential door
with threshold
1 vent

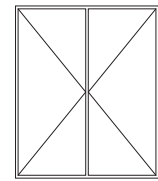

Residential door
with threshold
2 vents

Hydro Building Systems UK Limited,
Severn Drive, Tewkesbury,
Gloucestershire GL20 8SF
UK
Tel. +44 1684 853 500
www.technal.com



By  Hydro